



ICOLD Symposium on Sustainable Development of Dams and River Basins, 24<sup>th</sup> - 27<sup>th</sup> February, 2021, New Delhi

# OPTIMIZATION IN DESIGN OF ENERGY DISSIPATION ARRANGEMENT FOR OVERFLOW, ORIFICE AND TUNNEL SPILLWAY USING HYDRAULIC MODELLING

**PRAJAKTA P. GADGE**

*Scientist B, Central Water and Power Research Station, Pune, India*

**M. R. BHAJANTRI**

*Scientist E, Central Water and Power Research Station, Pune, India*

**V. V. BHOSEKAR**

*Director, Central Water and Power Research Station, Pune, India*

## ABSTRACT

*Dissipation of kinetic energy generated at the toe of a spillway is essential to avoid damage to the dam and its adjoining structures. Hydraulic characteristics of overflow, orifice and tunnel spillway are entirely different. Overflow spillways are the common type and are studied extensively throughout the world. This type of spillway is more preferable on valleys where width of river is more to provide sufficient crest length. Orifice spillways are generally used in Himalayan region to pass the flood as well as flushing of sediments from reservoir. Due to high discharge intensity of the order of 200-340 m<sup>3</sup>/s/m, the design of energy dissipation arrangement becomes complex and challenging to design engineers. Tunnel spillway is used advantageously at dam sites in narrow canyons with steep abutments or at sites where there is a danger to open channel from rockslides or snow. These spillways also pose peculiar problems for energy dissipation that necessitate special considerations during the design stage. The design of spillways is site specific and may vary from project to project. The role of hydraulic model studies is crucial in finalizing the design of spillway and its appurtenant structures. This paper describes the various alternatives carried out to optimize the design of energy dissipators and recommendations given by CWPRS for Overflow spillway of Omkareshwar multipurpose project, M.P., Orifice spillway of Pare H. E. Project, Arunachal Pradesh and Tunnel spillway of Parbati stage-3 H. E. Project, Himachal Pradesh using physical model studies.*

## 1. INTRODUCTION

Modern dams and hydraulic structures are frequently of immense size, requiring the control of large volumes of water under high pressures. The energies at the base of the structures are often tremendous whether the discharge through outlet conduits or over spillways. Some means of dissipating the energy of the high velocity flow are required to prevent erosion of the riverbed, flanks and prevent undermining of the dam itself. This may be accomplished by constructing an energy dissipator at the base of the structures designed to dissipate the excessive energy and establish safe flow conditions in the outlet (Khatsuria, 2004).

Overflow spillways are the common type and are studied extensively throughout the world. This type of spillway is more preferable on valleys where width of river is more to provide sufficient crest length. Orifice spillways are generally used in Himalayan region to pass the flood as well as flushing of sediments from reservoir. Hydraulic characteristics of orifice spillway are entirely different than overflow spillway. Due to high velocities of the order of 20-30 m/s over the spillway crest corresponding to discharge intensity of the order of 200-340m<sup>3</sup>/s/m, the design of energy dissipation arrangement becomes complex and challenging to design engineers. Steep bed slopes of the rivers in the hilly regions result in low tail water depth permitting two choices of energy dissipators, ski-jump bucket and stilling basin. However, ski-jump bucket is found to be the most suitable because of its obvious advantage during flushing operation. A hydraulic jump stilling basin may be adopted where geological conditions are not favourable. Tunnel spillway is used advantageously at dam sites in narrow canyons with steep abutments or at sites where there is a danger to open channel from rockslides or snow. The flow at the outlet end of tunnel is always a free surface flow. Generally the tunnel exit portals are located on the flanks and hence flip buckets are the most commonly used energy dissipators. Sometimes the tail water conditions

at the tunnel exit are such that a hydraulic jump may form for lower discharges, yet the tail water depths corresponding to higher discharges are inadequate for the formation of hydraulic jump. In such cases, a dissipator in the form of combination stilling basin flip bucket would be suitable i.e. stilling basin for lower discharges and flip bucket for higher discharges.

The factors that govern the choice of the type of energy dissipator are hydraulic considerations, topography, geology, type and purpose of the dam, layout of the associated structures, economic comparison, frequency of usage, as well as special and environmental considerations. Hence, design of energy dissipator is site specific and may vary from project to project. Hydraulic characteristics of overflow, orifice and tunnel spillway are entirely different. Available guidelines for design of energy dissipator cannot be directly applied to any type of spillway.

Hydraulic model studies play an important role in optimizing the design of energy dissipator for various types of spillway. The present study discusses the various alternatives carried out on physical model to optimize the design of energy dissipator for overflow, orifice and tunnel spillway. Three real life spillway projects viz. Omkareshwar dam spillway, M.P. (commissioned in 2007), Pare dam spillway, Arunachal Pradesh (commissioned in 2017) and Parbati stage-3 dam spillway, Himachal Pradesh (commissioned in 2014) are selected for the study. Results obtained from the study are discussed in detail in the present paper.

## 2. ENERGY DISSIPATION FOR OVERFLOW SPILLWAY

### 2.1 The project (case study 1)

The Omkareshwar multipurpose project is constructed downstream of Indirasagar project on the Narmada river. The concrete dam of height 64 m and 949 m long was constructed with central ogee spillway in 570 m length. The spillway consists of 23 spans of 20 m width equipped with radial gates of size 20 m x 18.03 m. The crest of the spillway is at El. 179.6 m. The spillway is designed to surplus the outflow flood of 88,315 m<sup>3</sup>/s corresponding to the probable maximum flood with high flood level at El. 199.62 m. The power house is on the right bank with installed capacity of 520 MW (8 X 65MW) and irrigation of approximately 2,83,300 hectares of land annually. Slotted roller bucket is provided as energy dissipator at the toe of spillway. Figure 1 shows cross section of spillway.

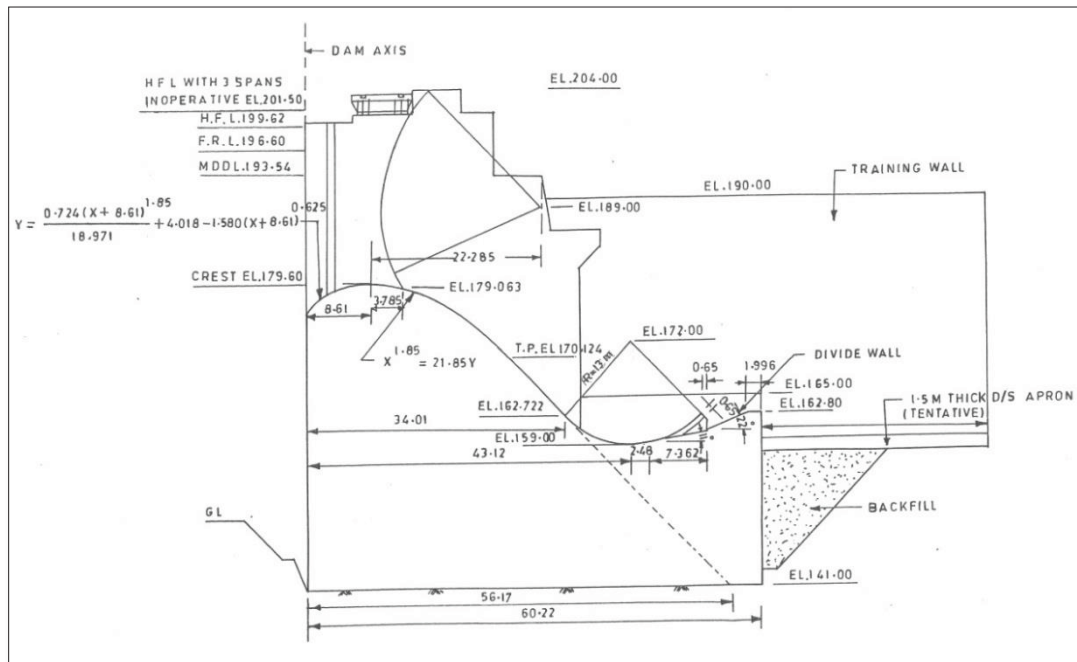

Figure 1 : Cross section of overflow spillway with slotted roller bucket

### 2.2 Physical model studies for original design of energy dissipator

Hydraulic model studies were conducted on 1:50 scale 2D sectional model at CWPRS, Pune. The performance of original design of energy dissipator in the form of slotted roller bucket was observed for the entire range of discharges up to maximum outflow flood of 88,315 m<sup>3</sup>/s with corresponding tail water levels maintained at 275 m downstream of dam axis. The performance of bucket was observed by lowering and raising tail water levels by 10% with respect to normal tail water depths considering all spans in operating conditions. The roller action was not formed for lower discharges. The weak surface and ground rollers were formed for higher discharges. However, they were ineffective to dissipate the energy. The flow conditions were similar to hydraulic jump and roller action did not prevail due to high tail water level. The design of the roller bucket was not found acceptable for the entire range of discharges. Downstream

face of the teeth was subjected to large negative pressures indicating possibility of cavitation damage. Improvement in the performance of bucket could not be achieved by modifying various parameters of slotted roller bucket due to high discharge intensity and incoming velocities. Hence, design was modified into stilling basin type energy dissipator and further studies were carried out.

### 2.3 Physical model studies for modified design of energy dissipator

A tentative layout of the stilling basin having length of 70 m was evolved considering the constraints at site such as location of downstream cofferdam, foundation condition and downstream river morphology. Figure 2 shows the cross section of the spillway and stilling basin. The stilling basin apron was kept at El. 158 m with 5 m high dentated end sill and 5 m high x 5 m wide chute blocks. Performance of stilling basin was observed by lowering and raising the tail water levels by 10 % with respect to normal tail water depth for all the discharges.

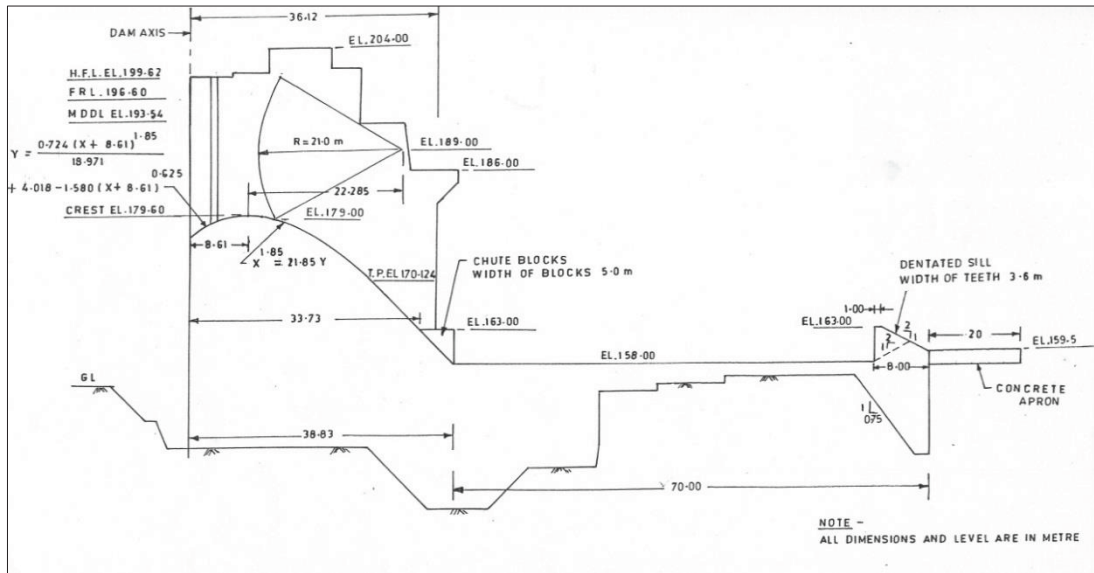

Figure 2 : Cross section of overflow spillway with 70 m long stilling basin with apron at El. 158 m

The studies indicated the stable jump formation in the stilling basin for discharges 22079 m<sup>3</sup>/s (25%) and 44157 m<sup>3</sup>/s (50%) for spillways operated in gated conditions. Hydraulic jump remained same even if the tail water level was lowered and increased by 10%. However, for higher discharges i.e. 66,236 m<sup>3</sup>/s (75%) and 88315 m<sup>3</sup>/s (100%) with ungated operation of spillway, hydraulic jump was not formed in the stilling basin. The thick jet was seen plunging into the pool of water generating surface fluctuations which traveled downstream of stilling basin. The inadequate length of stilling basin and excessive submergence due to higher tail water levels resulted in submerged hydraulic jump. Less violent surface fluctuations were observed for higher tail water levels, whereas for lower tail water levels more intensive surface fluctuations were observed. Large negative pressures were observed on the chute block for lower discharges indicating high possibility of cavitation damage. For higher discharges, though the pressures were positive, the chute blocks were not at all effective in splitting the thick jet. The following alternatives were carried out on the model to optimize the layout of stilling basin.

1. Stilling basin with dentated end sill and without chute blocks (Alternative 1).
2. Stilling basin with dentated end sill, without chute blocks and with 5 m high baffle blocks (Alternative 2).
3. Stilling basin with upstream sloping solid end sill, without chute and baffle blocks with apron level at El. 156 m (Alternative 3).

The performance of stilling basin with dentated end sill and without chute blocks were found to be same as observed with chute blocks. Hence, it was recommended to eliminate chute blocks from stilling basin. For Alternative 2, violent flow conditions persisted in the stilling basin upstream of baffle blocks upto 50% of maximum discharge. However, flow conditions were improved substantially for higher discharges. The stilling basin would operate most of the time for discharges of 50 % and lower, and as such, further optimization of the height of baffle blocks was not considered suitable.

In Alternative 3, the stilling basin apron was lowered by 2 m to prevent sweep out of the hydraulic jump out of the basin for lower discharges in absence of required tail water downstream. Basin was provided with 7 m high solid end sill with upstream slope 2:1 and top width 1 m with top El. 163 m. Studies indicated that for the discharges upto 60 % of maximum outflow flood i.e. upto 55,000 m<sup>3</sup>/s, stable jump was formed without appreciable waves downstream of stilling basin. The flow downstream of stilling basin was without any appreciable surface waves. However for the discharges beyond 60 % of maximum outflow flood, although the fluctuating surface waves persisted, their amplitude

was very much reduced by lowering apron level by 2 m. The hydraulic jump was largely contained within the stilling basin. It was also observed that there was no possibility of sweep out of hydraulic jump out of the basin for lower discharges. As such the design of stilling basin with apron at El. 156 m with upstream sloping solid end sill without chute and baffle blocks was optimized from physical model studies. Figure 3 show the performance of stilling basin for, 50% and 100% of design discharge respectively. It was also suggested from physical model studies that a 20 m long solid concrete apron with a key at the downstream end may be provided to safeguard the stilling basin from likely undermining of the stilling basin due to scour.

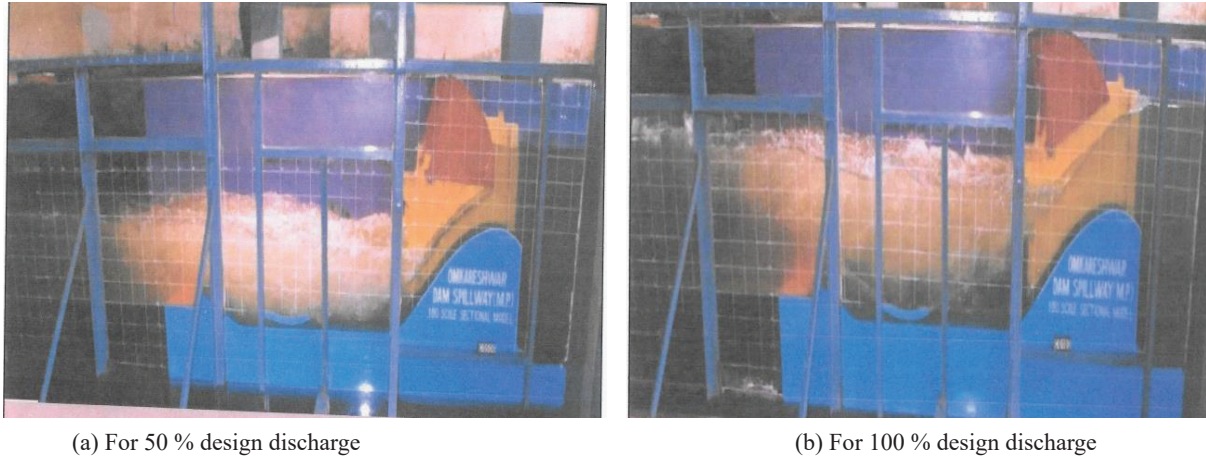

**Figure 3 :** Performance of stilling basin with apron at El. 156 m

Due to high discharge intensity (up to 155 m<sup>3</sup>/s/m) and incoming velocities of the order of 25 to 28 m/s, various alternatives of energy dissipators were carried out on physical model to finalize the design for adoption.

### 3. ENERGY DISSIPATION FOR ORIFICE SPILLWAY

#### 3.1 The project (case study 2)

The Pare H.E. Project is a run-of-river scheme on the river Dikrong/Pare river downstream of the power house of the first stage of Ranganadi H. E. project in Arunachal Pradesh. The project envisages construction of a 78 m high concrete gravity diversion dam, about 3 km long water conductor system and a surface power house with an installed capacity of 110 MW. The breastwall has been provided to pass the flood as well as to flush the sediments deposited in the reservoir into the river downstream. The spillway is designed to pass the maximum design outflow flood of 5000 m<sup>3</sup>/s through 3 orifice openings of size 10.4 m wide x 14 m high with crest level at El. 216 m. The FRL and MWL have been fixed at El. 245.15 m and 246.216 m respectively. Radial gates have been provided at the downstream face of breastwall for controlling outflow discharge. A ski-jump bucket of 18 m radius and 400 lip angle is provided for energy dissipation. Power intake of installed capacity 110 MW was located on the right bank at about 40 m upstream of dam axis. Figure 4 shows cross section of spillway.

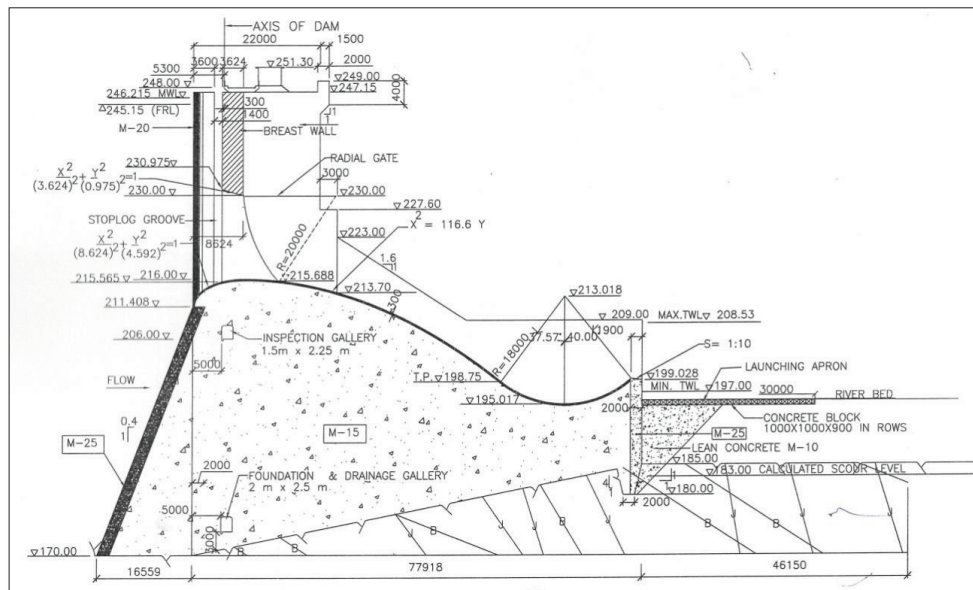

**Figure 4 :** Cross section of original design of orifice spillway for Pare H. E. Project, Arunachal Pradesh

### 3.2 Physical model studies for original design of energy dissipator

1:60 scale comprehensive model of Pare dam spillway was constructed in a closed hangar. The hangar has the high level water tank and low level sump including pumping arrangements with re-circulating system to maintain the required flow of water in the physical model. The model incorporates the river portion up to 1200 m upstream and 600 m downstream of dam axis. The river bed and banks were reproduced rigid in smooth cement plaster. Various spillway components such as spillway, bottom profile, piers, training walls, breastwalls and radial gates were reproduced using PVC foam sheet. Power intake structure and about 60 m reach of intake tunnel were fabricated in transparent Perspex.

The performance of ski-jump bucket was observed for various discharges. The maximum tail water at 300 m downstream of dam axis was at El. 208.53 m. As the tail water level was higher than the lip level El. 199.028 m, no clear ski-jump action was observed. The ski-jump jet was not getting lifted in the air for all the discharges. Therefore, it was suggested to raise the bucket lip at least by 3 m. The throw of the ski-jump jet varied from 65 m to 80 m from bucket lip. The flow in the river downstream beyond point of impingement of the jet remained supercritical with high velocity of the order of 20 m/s pushing the tail water up to about 400 m downstream of dam axis. The flow conditions in the river further downstream were violent. During the initial years of operation of spillway, the impact of the ski-jump jet on the river bed and high velocity supercritical flow downstream would result in progressive erosion of the river bed and banks. In order to avoid uncontrolled erosion of river bed and banks, it was recommended to provide a pre-formed plunge pool for dissipation of excess energy of the ski-jump jet.

### 3.3 Physical model studies for modified design of energy dissipator

In the revised design, the ski-jump bucket of 30 m radius with exit angle of 35° was provided for energy dissipation and lip elevation raised up to El. 202.406 m by steepening the spillway bottom profile conforming to equation  $x^2 = 100y$ . Preformed plunge pool was also provided to improve the downstream flow conditions.

After reproduction of pre-formed plunge pool, the excess energy of the jet got dissipated and the flow in the river beyond the point of impingement remained subcritical with the velocity of about 5 to 10 m/s. Figure 5 shows the flow conditions downstream of spillway for discharges 1250 m<sup>3</sup>/s and 5000 m<sup>3</sup>/s. This resulted in boosting up of the tail water levels by 3 m to 6 m compared to the tail water rating curve supplied by the project authority. The bucket lip and lower nappe of ski-jump jet was getting submerged due to higher tail water levels for the discharge higher than the 1250 m<sup>3</sup>/s (25%). However, the performance of ski-jump bucket was not hampered. Hence, revised design of energy dissipator with pre-formed plunge pool was found to be satisfactory for dissipation of excess energy of the ski-jump jet.



(a) For Q = 1250 m<sup>3</sup>/s

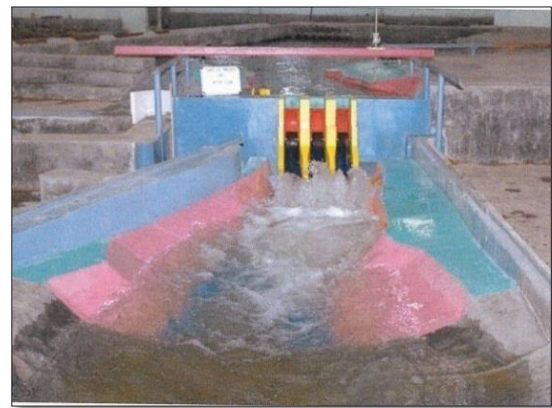

(b) For Q = 5000 m<sup>3</sup>/s

Figure 5 : Flow conditions downstream of spillway

## 4. ENERGY DISSIPATION FOR TUNNEL SPILLWAY

### 4.1 The project (case study 3)

The Parbati stage -3 H. E. Project is a multipurpose project on the river Sainj, a tributary of Beas in Kullu district of Himachal Pradesh. This will receive water from the tailrace of Parbati Stage 2. The project has 43 m high rock fill dam on river Sainj and underground powerhouse with installed capacity of 520 MW at village Bihali near confluence of Sainj and Beas Rivers. An orifice spillway having two spans of 7.2 m width and 14 m high is provided to pass the maximum discharge of 3300 m<sup>3</sup>/s at FRL El. 1330 m and also to flush the sediment deposited in the reservoir to the river downstream. Two tunnels of diameter 6.75 m, horse shoe shape, 440 m and 480 m long respectively have been provided on the right bank of the river for diversion of water during construction of dam. The elevation at the entrance and at the exit is 1300 m and 1286 m respectively. It is proposed to utilize these diversion tunnels as tunnel spillway, in addition to orifice spillway. Figure 6 shows layout plan of the project. A bell mouth curve is provided at the entry of tunnel spillway.

Ski jump bucket of radius 22.4 m with lip angle 30° is provided at the outlet of tunnel for energy dissipation as shown in Figure 7.

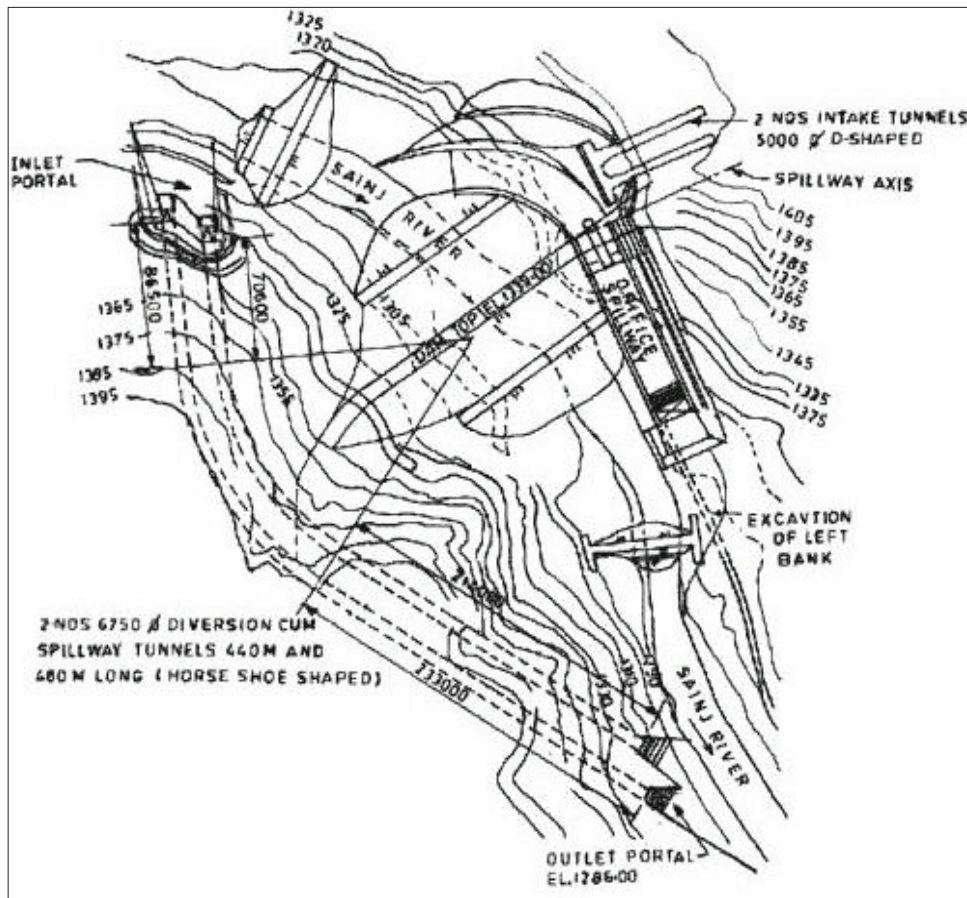

Figure 6 : Layout of the project

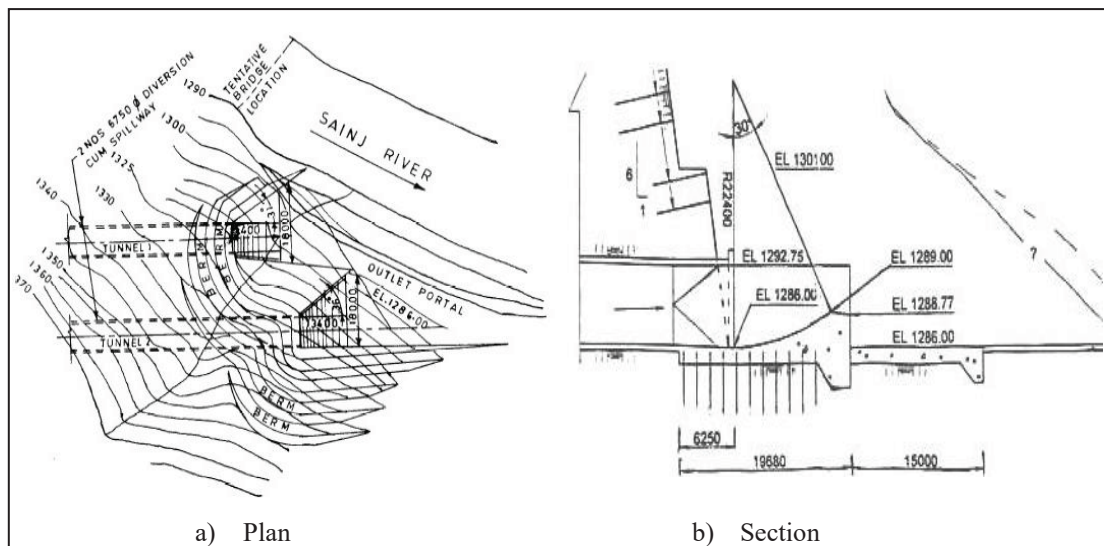

Figure 7 : Plan and section of tunnel outlet

#### 4.2 Physical model studies for original design of energy dissipator

Based on Froudian criteria, a 3-D comprehensive model of Parbati dam comprising of orifice spillway, diversion cum tunnel spillway, rockfill dam and power intake was constructed with a geometrically similar scale of 1:50. The river topography, about 650 m upstream and 550 m downstream of dam axis was reproduced with surface finished in cement mortar. The tunnel spillway consisting of intake structure, control structure, transition and discharge tunnel was reproduced in perspex sheet. Ski- jump bucket at the outlet was reproduced in masonry with smooth cement plaster.

### 4.3 Physical model studies for original design of energy dissipator

Studies were carried out for determining the performance of energy dissipator for various reservoir water levels. Ski jump bucket was not performing satisfactorily in lifting the jet because of large depth of flow and low velocity. As the jet was riding over the left bank with high velocity, there was possibility of erosion and damage to left bank. Figure 8 shows the flow condition at the outlet of tunnel spillway for FRL El.1330 m.



**Figure 8** : Flow conditions at the outlet of tunnel spillway

### 4.4 Physical model studies for modified design of energy dissipator

As the ski-jump bucket provided at the outlet of tunnel spillway was not suitable, it was suggested to provide 40 m long stilling basin with baffle blocks at apron El. 1282 m. Due to space constraints at site, length of stilling basin was reduced by 12 m. Following alternatives were studied to optimize the design of energy dissipator.

1. 28 m long stilling basin with two rows baffle blocks and straight end sill parallel to the tunnel outlet (Alternative I).
2. 28 m long stilling basin with three rows baffle blocks and oblique endsill approximately parallel to right bank (Alternative II).
3. 22 m long stilling basin with three rows baffle blocks, oblique endsill and reduction in flaring of side wall from 140 to 100 (Alternative III).

The performance of stilling basin was evaluated by measuring the velocities at tunnel exit and end sill of the basin and observing the flow conditions downstream of end sill. More reduction in velocity improves the energy dissipation in the basin. The velocity at tunnel exit was observed as 20 m/s for spillway operated at FRL EL. 1330 m. This velocity was compared with the velocity observed at the end sill for various alternatives. In Alternative I, velocity at end sill was observed as 19 m/s. There was only 5% reduction in velocity observed in the basin. Due to this marginal reduction in dissipating the energy, Alternative - I was not found suitable layout for proper energy dissipation. In Alternative II, velocity measured at end sill was 8 m/s which was much lower than 19 m/s observed for Alternative I. The velocity was reduced by about 60 % with additional row of baffle block in 28 m long stilling basin. Provision of oblique end sill helped in guiding the flow towards main river channel. Thus, the performance of stilling basin for Alternative II was found satisfactory as compared to Alternative I. However, the design was further modified due to space constraints at site. Modified design consisted of 22 m long stilling basin with three rows baffle blocks and oblique endsill. The flaring of side wall was reduced from 140 to 100. At end sill, the velocity was observed as 13 m/s, which was 1.6 times more than the velocity observed for Alternative II. There was only 35% reduction in velocity observed in the basin, which was found to be less than Alternative II. However, due to space limitations at site, it was recommended to provide stilling basin as per Alternative III layout as shown in Figure 9. Figure 10 shows the flow conditions in stilling basin at FRL El. 1330 m.

It shows very turbulent conditions downstream of end sill. Even turbulence was seen travelling towards left bank. The high velocity of flow leaving the endsill would be further dissipated due to the tail water depth. The studies indicated that the left bank would be subjected to velocities ranging from 4 to 5 m/s. As such the possibilities of eroding the toe of the left bank in front of the tunnel outlets cannot be ruled out and suitable protection have to be provided on the left bank. The endsill of the stilling basin of both tunnels encroach in the river section. As such it would not be possible to provide apron downstream of the endsill, and the possibility of erosion at the toe can not be ruled out. Therefore, it was recommended to provide a key of at least 6 to 7 m into the fresh rock at downstream of the endsill so as to protect the stilling basin from undermining.

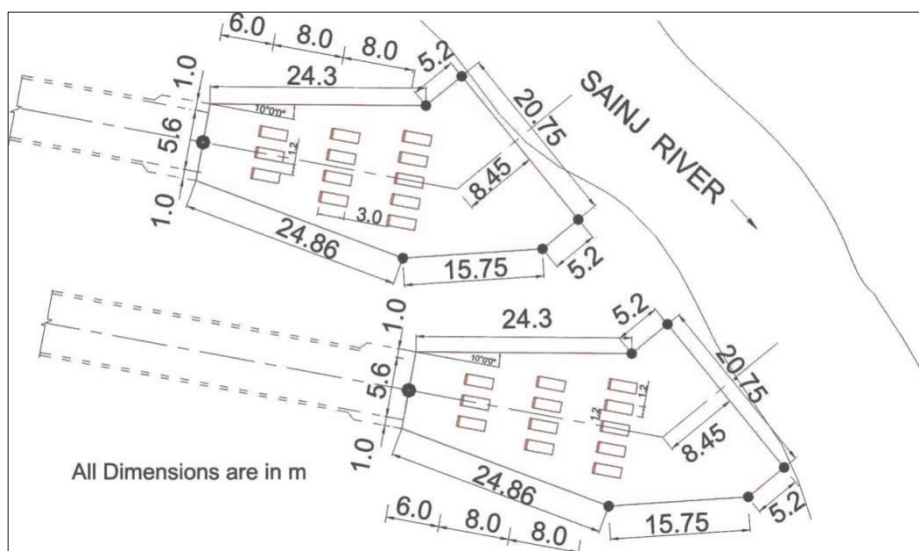

Figure 9 : Plan of stilling basin for Alternative III

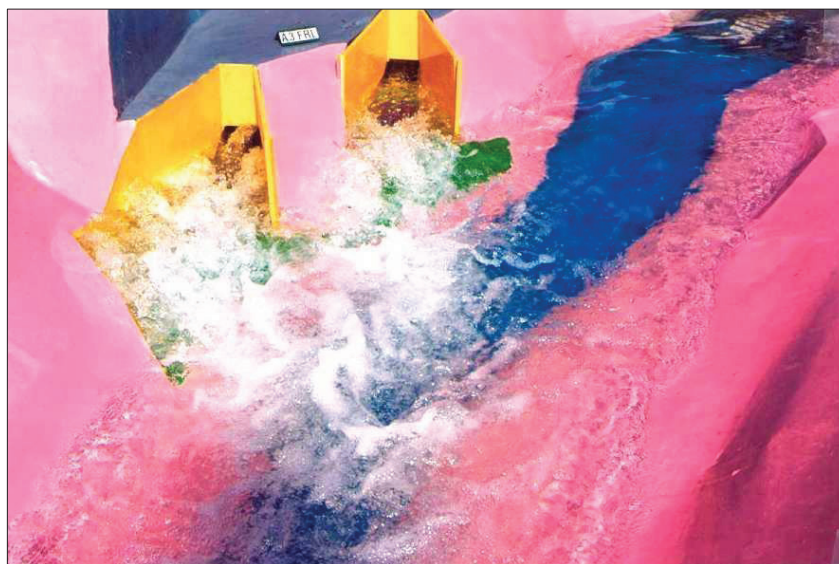

Figure 10 : Flow conditions in stilling basin for Alternative III.

## 5. CONCLUSIONS

The present paper discussed the studies to optimise the design of energy dissipators for overflow, orifice and tunnel spillway based on physical model studies. Three case studies namely Omkareshwar dam spillway, M.P., Pare dam spillway, Arunachal Pradesh, Parbati stage-3 dam spillway, Himachal Pradesh were selected for the study. Due to the different hydraulic design criteria, three different types of spillways were considered whose design was optimized by carrying out various alternatives on physical model. The results obtained from the study are discussed below.

- **Omkareshwar multipurpose project, M. P. (Overflow spillway)** : Due to high discharge intensity (up to 155 m<sup>3</sup>/s/m) and incoming velocities (25 to 28 m/s), the original design of slotted roller bucket was not effective to dissipate the energy. Therefore, the design was modified into stilling basin with its appurtenant structure such as chute and baffle blocks. The apron level was lowered by 2 m to improve the flow conditions in the basin. It was also suggested to provide 20 m long solid concrete apron with a key at the downstream end to safeguard the stilling basin from likely undermining of the basin due to scour.
- **Pare H.E. project, Arunachal Pradesh (Orifice spillway)** : The bucket lip was raised by 3 m to improve the performance of energy dissipation. The flow conditions in the river further downstream of impact of jet were violent with the velocity of 20 m/s. In order to avoid uncontrolled erosion of river bed and banks at the downstream, it was recommended to provide a pre-formed plunge pool for dissipation of excess energy of the ski-jump jet. The revised design of energy dissipator with pre-formed plunge pool was found to be satisfactory for dissipation of excess energy of the ski-jump jet.



- **Parbati stage-3, Himachal Pradesh (Tunnel spillway)** : The original design of energy dissipator with ski jump bucket was not performing satisfactorily in lifting the jet because of large depth of flow and low velocity observed at the tunnel outlet. As the jet was riding over the left bank with high velocity, there was possibility of erosion and damage to left bank. As per the site conditions, the design was modified into stilling basin with its appurtenant structures such as baffle blocks and end sill. The design was finalized and recommended for adoption at the site based on the extensive studies carried out on physical model. It was also recommended to provide a key of at least 6 to 7 m into the fresh rock at downstream of the endsill so as to protect the stilling basin from undermining.

Thus, physical model studies played a vital role in optimizing the design of energy dissipators for overflow, orifice and tunnel spillway.

## **REFERENCES**

- CWPRS 2004. Hydraulic model studies for Omkareshwar dam spillway, M.P. Technical Report no. 4170.
- CWPRS 2007. Hydraulic model studies for tunnel spillway of Parbati H. E. Project, stage - 3, Himachal Pradesh. Technical Report no. 4461.
- CWPRS 2012. Hydraulic model studies for Pare dam spillway, Arunachal Pradesh. Technical Report no. 4922.
- Khatsuria, R. M. (2004). Hydraulics of spillway and energy dissipators. Marcel Dekker publication, New York, NY.