



ICOLD Symposium on Sustainable Development of Dams and River Basins, 24th - 27th February, 2021, New Delhi

HIGH PRECISION DETECTION TECHNOLOGY FOR DAM LEAKAGE BASED ON MAGNETOELECTRIC RESISTIVITY METHOD

HUAMIN ZHOU, GUOQIANG XIAO, LIMING ZHOU AND MIN ZHANG
Changjiang River Scientific Research Institute, Wuhan, China

ABSTRACT

The detection of leakage passage plays an important role in eliminating hidden danger of dam. However, high-quality detection remains a challenging task. Some existing geophysical methods such as high density electrical method, flow-fitting method, nuclear magnetic resonance method and acoustic emission method are still limited in accurately and quantitatively interpreting leakage channels. This paper proposes a rapid detection technology for leakage passage in dam based on magnetoelectric resistivity method. The forward simulation method of magnetoelectric resistivity is studied to reveal the abnormal distribution of alternating electromagnetic field caused by leakage conductive circuit. The field survey layout method is proposed with the combination of rough and careful observation. The N current electrodes are applied to dynamic track and accurate position the evolution process of the leakage passage. Numerical simulation and physical model test show that the technology proposed in this paper can detect the leakage passage quickly and accurately. Thus, it provides guidance for the treatment and repair of the leakage in dam.

1. INSTRUCTION

The quality and safe operation of dam projects are related to the safety of people's lives and property. As the dam structure is complex and the construction-age is long, there are leakage and other safety hidden dangers. The detection of leakage passage is always the key and difficult point. At present, the detection methods for potential leakage can be divided into three categories: first, based on the electrical differences between leakage passages and surrounding media, which is the good conductivity of leakage. The distribution of leakage can be found out by using electrical method, including transient electromagnetic method, high-density resistivity method, flow-field method and so on. Transient electromagnetic method (TEM) has blind spots, so it is difficult to effectively identify the hidden leakage in shallow surface. The high density resistivity method has obvious volume effect and low vertical resolution. The flow field method can't determine the channel and direction of leakage in the dike body. The second method is the physical and chemical action of leakage, including isotope tracer method, nuclear magnetic resonance method and sound emission method. Isotope tracer method is used to measure the movement and leakage state of underground water flow with natural or artificial radioactive tracer. This method is suitable for the detailed investigation of hidden dangers, but lacks quantitative explanation. Nuclear magnetic resonance (NMR) method needs to overcome the interference of river water in detecting leakage. Acoustic emission method is based on the sound of water flow and the sound of friction between water and soil when dam leakage occurs, and it can only be described qualitatively. The third method is to monitor the dynamic change process of dam leakage through repeated detection, and track the generation and development process of dam leakage. Dam safety monitoring is a long-term process, which is difficult to play an emergency role.

Generally speaking, the current methods and technologies for detecting dam leakage have their advantages and disadvantages. Although some achievements have been made, there are still many shortcomings in the research on the accurate location of dam leakage channels and the quantitative interpretation of detection results. The ground magnetometric resistivity (MMR) is a conductive electromagnetic-like exploration method for measuring magnetic field on the ground. Ground MMR has the characteristics of no grounding of measuring device, fast measuring speed, little impact on environment and high economic benefit. At present, MMR method has been applied in the field of traditional geological structure survey and ore-prospecting. The research of Goldman and Neubauer(1994) on groundwater exploration showed that the combination of MMR and time-domain electromagnetic method (TDEM) was the most suitable in terms of technology and principle for the exploration of groundwater distribution and water volume. Kullessa et al. (2002) first introduced MMR in the laboratory environment to judge solute migration in groundwater. Willowstick technologies inc. accurately simulated the flow of groundwater through MMR, and it plays a key role in geophysical investigations such as DAMS, mines, environmental monitoring sites and garbage leaching fields (Kofloed et al., 2011;Kofloed, 2013).

In this paper, a method for detecting dike leakage channel based on magnetic resistivity method is proposed, and the location of leakage channel is confirmed by measuring the abnormal distribution of alternating electromagnetic field caused by the current circuit formed by leakage passage on the surface of the dam. The abnormal distribution of alternating electromagnetic field caused by leakage circuit is revealed through the three-dimensional magnetic resistivity forward modeling method. This paper puts forward the method of observation of abnormal leakage magnetic field by combining rough measurement with fine measurement, and realizes the dynamic tracking and accurate positioning of leakage passage evolution process by time-shifting multi-phase detection of magnetoresistivity. The results of numerical simulation and physical model test show that the leakage detection method proposed in this paper can detect the leakage passage quickly and accurately, providing guidance for the management and repair of the dam leakage..

2. METHOD AND THEORY

2.1 The principle of electric method for dam leakage exploration

Electrical exploration mainly studies the resistivity distortion law caused by hidden danger according to the difference of conductivity between hidden danger and surrounding medium, and deduces the nature, occurrence and buried depth of hidden danger by combining geological conditions and dam structure characteristics. The main factors influencing the electrical conductivity of dam structure are lithology, moisture content, density, and so on. Among them, water content has a great influence on the electrical structure of the levee. When the levee soil is homogeneous and there are no hidden dangers, the resistivity decreases gradually. When the dam has leakage hidden danger and leakage passage, the electrical conductivity of hidden danger area goes up obviously.

Resistivity (r) and moisture content (W) show a decreasing power function relationship:

$$r = a \times W^{-b} + c \quad \dots(1)$$

Where, a is the comprehensive structure parameter of soil mass, b is the constant related to compactness, and c is the curve characteristic of relational constant.

Fig.1 shows the curve of resistivity of embankment soil with water content under different compactness of silt loam of Yangtze River embankment in China. It can be seen that, under a certain degree of compactness, the larger the moisture content, the smaller the resistivity. When the moisture content is less than 12%, that is, the unsaturated state, with the increase of moisture content, the decrease rate of resistivity is accelerated and the curve gradient change is enhanced. Between 12% and 30%, with the increase of moisture content, the decrease rate of resistivity slows down. When the moisture content is greater than 30%, the resistivity is less affected by the moisture content as the moisture content increases. Therefore, when there is leakage in the dam, the change of water content has a great impact on the resistivity. By observing the change of the conductivity of the dam within the detection range, the leakage passage of the dam can be determined.

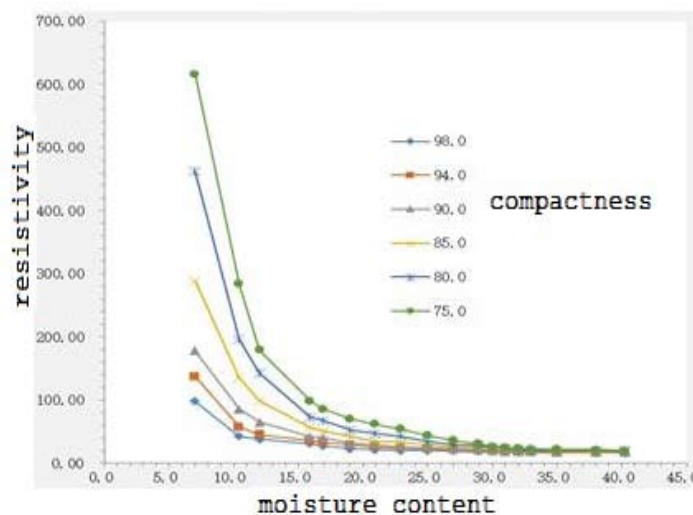

Figure 1 : Curve of resistivity and moisture content.

2.2 MMR method

The magnetometric resistivity (MMR) method involves the measurement of the low-level magnetic fields associated with non-inductive current energized into the ground through electrode pairs. DC current injection in subsurface will result in magnetic field. The MMR system is then moved over the area of interest to collect B-field data resulting from any resistivity contrasts. Observing the magnetic field at surface is equivalent to measuring the electrical potential

field at this location with the advantage of non-electrodes and has greater sensitivity to conductive targets under a moderately conductive overburden in comparison with geo-electrical technique. The magnetic induction associated with the conduction current in the crust satisfies the modified Biot-Savart law:

$$H = \frac{\mu_0}{4\pi} \int \frac{\nabla m \times \nabla s}{|r - r'|} d^3 r' \quad \dots(2)$$

Where m is the scalar electrical potential in V, s and μ_0 represent the electrical conductivity in S/m and magnetic permeability of free space in H/m. The most commonly used electrode arrangement of MMR is a gradient arrangement, which makes the power supply cable semi-rectangular to reduce the effect of the cable's magnetic field.

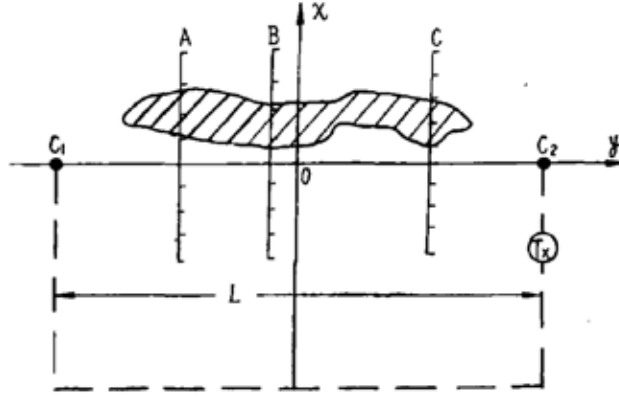

Figure 2 : The MMR arrangement diagram

Here A, B, C are survey lines. C_1 , C_2 are current electrodes. Tx is transmitter and L is electrode spacing. Assume that the underground medium is a uniform medium, and when C_1 and C_2 are powered by electricity, the normal magnetic field distribution formula along the x-axis on the surface is as follows:

$$H_n = 100I \left[\frac{y+1}{x^2 + (y+1)^2} - \frac{y-1}{x^2 + (y-1)^2} \right] \quad \dots(3)$$

Where H_n is the theoretical value of normal magnetic field at any point measured along the direction of survey line. I is the supply current in the supply field circuit, x is the survey direction, y is the connection direction of positive electrode rod and negative electrode rod. When dam has leakage passage, leakage passage location forms good conductors. Then the normal distribution of the uniform magnetic field forms will be destroyed, create abnormal magnetic field intensity in the leakage passage region. It can be determined the distribution of the seepage passage by measuring the change of magnetic field intensity. The field intensity at the center point $x=0$, $y=0$ can be obtained,

$$H_{n(0)} = \frac{200I}{l} \quad \dots(4)$$

The size of outliers is usually measured by the value of field intensity at the center point. In the process of magnetic field measurement, magnetic field static correction is required, and the mean value of background magnetic-field within the specified time is applied to correct the magnetic field data. It can be expressed as,

$$C = \frac{200I}{\bar{H}_p} \quad \dots(5)$$

Where \bar{H}_p is the mean value of the magnetic field measured by the static magnetic field receiver before, during and after works. R is the vertical distance between the static magnetic field receiver and the positive and negative electrode rod wires on the dam surface. The corrected magnetic field strength value can be obtained by multiplying the observed magnetic value at each point with correction factor C. According to the corrected magnetic field value of each measuring point, the corresponding underground magnetic resistivity value of each measuring point is calculated by the following formula:

$$MMR = \frac{H_p^c - (H_n \times I)}{\frac{200I}{l}} \times 100\% \quad \dots(6)$$

Where MMR represents the magneto-resistivity value inside the dam, and different from the resistivity mentioned in the electrical exploration, it is the ratio of the abnormal value to the theoretical value of the normal magnetic field. It is represented by the percentage value. H_n is the theoretical value of normal magnetic field in the homogeneous medium;

H_p^C is the magnetic field value corrected at each measuring point; I is the value of power supply current in the electric field circuit of power supply; l is half of the distance between the electric field negative pole and the electric field positive pole.

2.3 Dam leakage detection method based on MMR

The dam leakage detection method based on MMR is to supply power to both sides of the dam. When there is a suspected leakage channel inside the dam, due to the good conductivity of leakage, the current density at the suspected leakage channel significantly increases, forming an electric field circuit. The magnetic field intensity value on the top of the dike increases obviously, showing obvious abnormal distribution of magnetic field, thus we can quickly delineate the abnormal distribution position. The distance between the two electrodes of the electric field is 600~800 m, depending on the detection object and the work task. Its target is to expand the power supply loop as far as possible and reduce the interference of the power supply cable. Several survey lines are arranged in parallel along the top of the dam. The distance between the survey points in each survey line is 0.5-1m, so as to detect the magnetic field data changing in the whole space range.

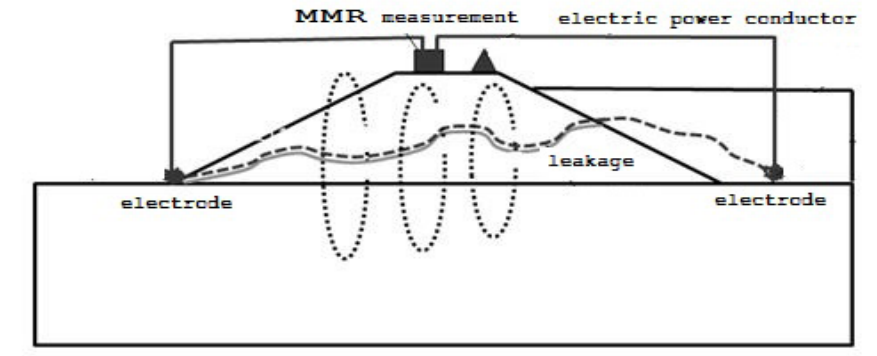

Figure 3 : The diagram of dam leakage detection method based on MMR.

In order to improve the detection efficiency and quickly find the leakage inlet, the detection method combining rough measurement and detailed measurement is adopted. A number of coarse measurement points are evenly selected in the water surface on the outside of the dam, and a number of power supply electrodes are arranged to conduct different power supply electrodes in turn to form a number of current circuits. The detailed measurement point is obtained by determining the maximum magnetic field data and its location. According to the detailed measurement, the precision measuring points are divided with equal spacing, then comparing the maximum value of magnetic field data to determine the leakage location.

3. NUMERICAL SIMULATION AND MODEL TEST

3.1 Numerical simulation

(1) Cylindrical leakage passage

The cylindrical leakage passage model is shown in figure 4-a, and y-axis direction indicates the dyke trend. The cylinder of Fig 4-b represents the flow path in the leakage path, and the red arrow represents the current direction. Cuboid represents dam, and its medium is set as concrete. The right side is the water side, and the left side is the inside side. The parameters of each medium are as follows: the relative permeability of water is 1 and its conductivity is $5.5e^{-6}$ (s/m), relative permittivity is 80. The relative permeability of concrete is 4.5 and its conductivity is $8e^{-4}$ (s/m), relative permittivity is 7. The magnetic field contour map is usually used to represent the relative magnitude of the magnetic field at each observation point.

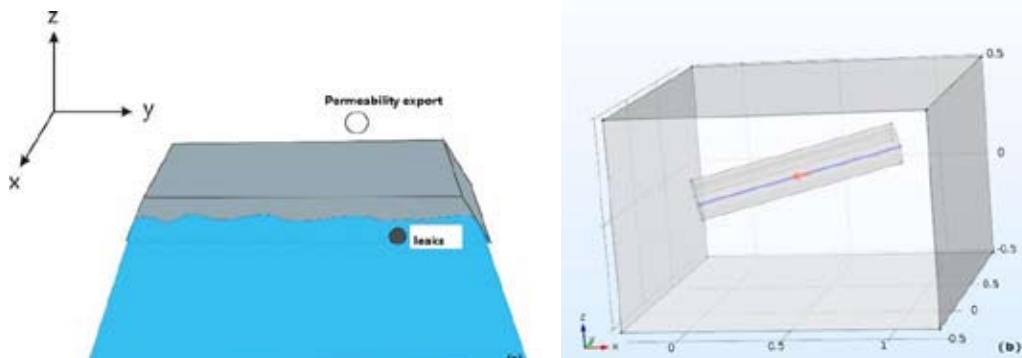

Figure 4 : (a) dam model. (b) the parameter of the cylindrical leakage passage model.

When the included Angle between the seepage passage and the dam strike is greater than 45 degrees, the magnetic field contour map is shown in figure 5a-b. Since we only need to compare the contour line, the value of the contour line is not shown in the result. Fig. 5-a is the contour map of the y-component of the magnetic field. It can be seen that the ellipse-like coils formed by the contour line have the same long axis direction as the horizontal position of the leakage path. In this case, the horizontal position of the leakage path can be well retrieved by the magnetic field contour map. Figure 5-b is the contour map of the x-component of the magnetic field. The inversion effect is not as good as that of the y-component contour map of the magnetic field.

When the Angle between the leakage path and the dike strike is less than 45 degrees, the x-component of the magnetic field is used to make the contour map, as shown in Figure 5-d. The direction of the long axis of the elliptical contour line is consistent with the horizontal position of the leakage path. Figure 5-c is an isometric map of magnetic field in y component, whose inversion effect is not as good as that of x component. Therefore, the horizontal component of magnetic field intensity can better reflect the direction of the anomalous body.

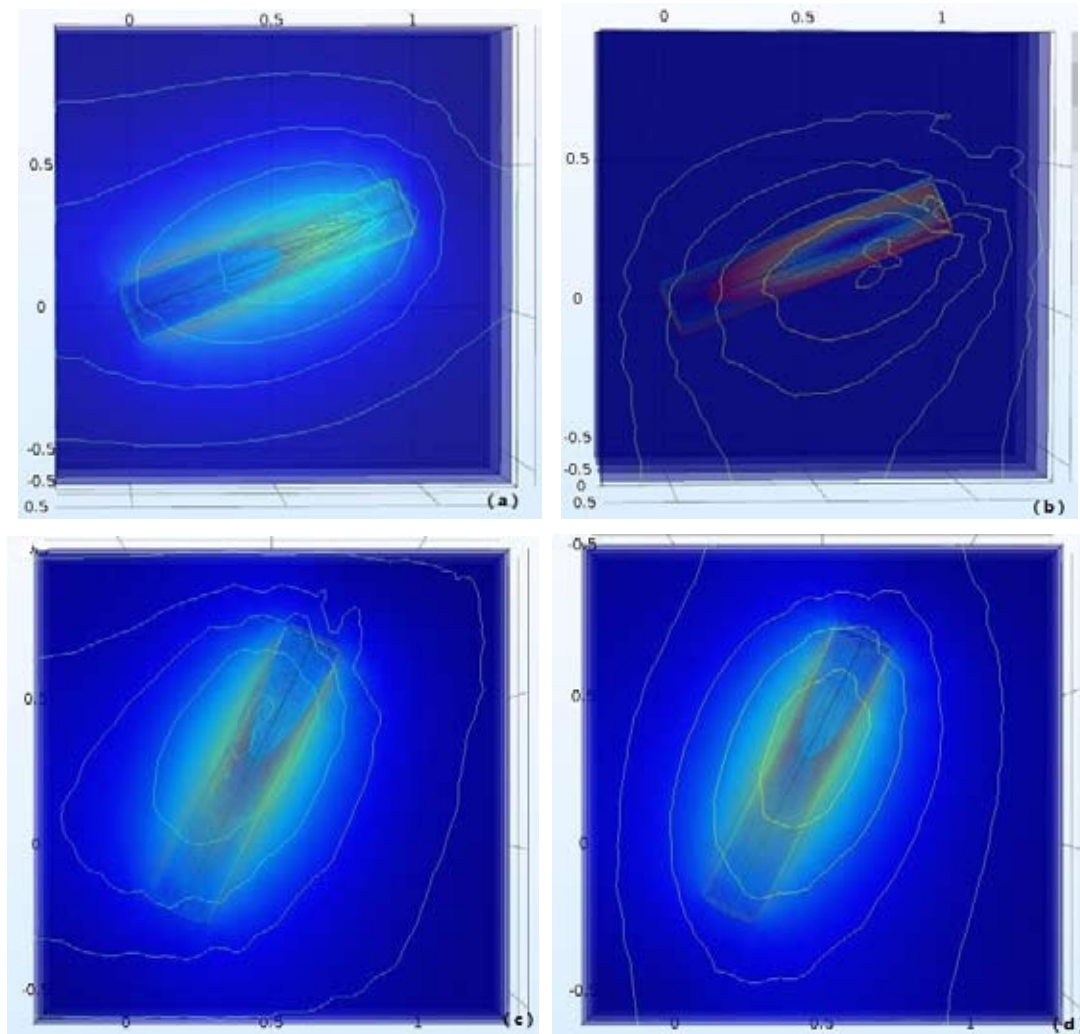

Figure 5 : The y component (a) and x component (b) of the magnetic field contour map with angle larger than 45°, and the y component (c) and x component (d) of the magnetic field contour map with angle less than 45°.

(2) Curved leakage passage

Figure 6-a shows the bending leakage path in the horizontal plane, and from figure 6-b , it can be seen that the long axis direction of the contour line and the direction indicated at the tip of the “V” shape represent the horizontal position of the leakage path. In this case, the horizontal position of the leakage path can also be reversed by magnetic field contour map. Figure 6-c shows the bending leakage path in space. Figure 6-d is the magnetic field contour map and comparing with the horizontal position of the leakage path, the long axis direction of the contour line and the direction indicated at the tip of the “V” shape represent the horizontal position of the leakage path.

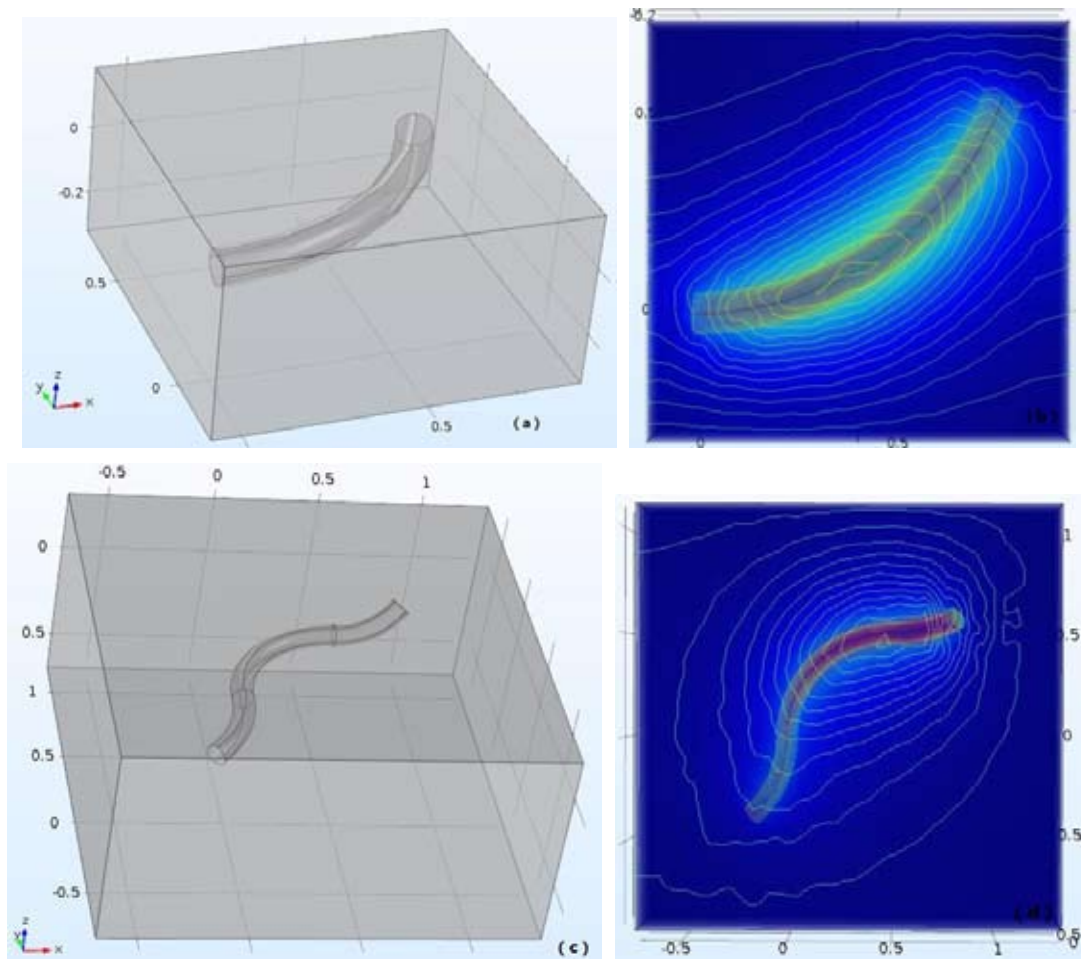

Figure 6 : Bending leakage path in the horizontal plane (a) and its the magnetic field contour map (b); bending leakage path in space (c) and its the magnetic field contour map (d).

From numerical simulation, the magnetic field contour map can invert the horizontal position of the leakage path. The horizontal position of the leakage path will be reflected by the line segment connecting the contour “V” tip to the long elliptical axis. The magnetic field component which is close to the direction of the leakage path can more accurately represent the direction of the leakage passage.

3.2 Model Test

The directional embedded method is applied to fabricate the embankment hidden danger physical model with 8 m long, 5 m wide and 3.5 m high. The PVC pipe with 20 cm diameter is used as leakage passage. The PVC pipe with perforated pipe is wrapped by geomembrane to simulate leakage process.

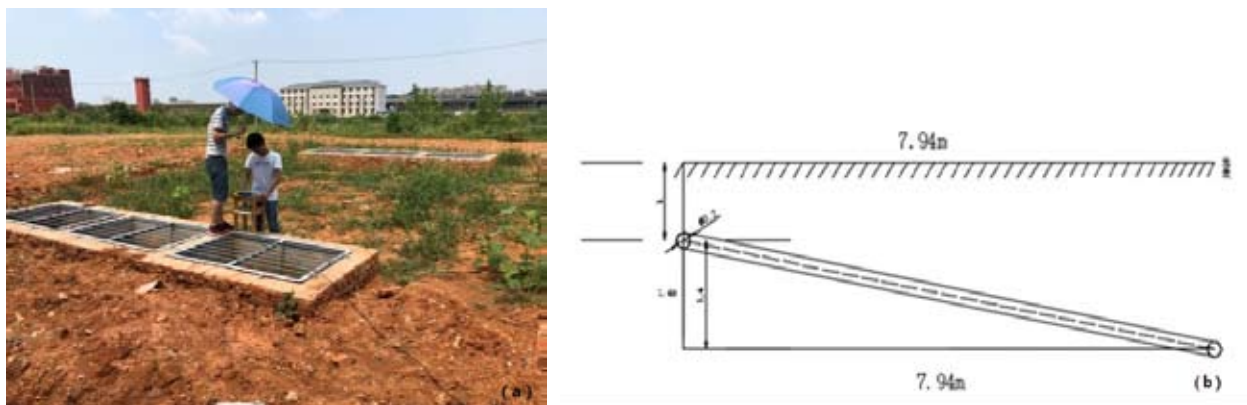

Figure 7 : (a) model test photo and (b) dam model section

Five measuring lines were arranged in parallel along the width of the physical model, with the spacing of measuring lines being 1.0m. The spacing of measuring points of each measuring line was 1.0m. After preliminary arrangement of the test data, the magnetic field distribution curves in x, y and z directions were drawn (as shown in Fig8 a,b,c).

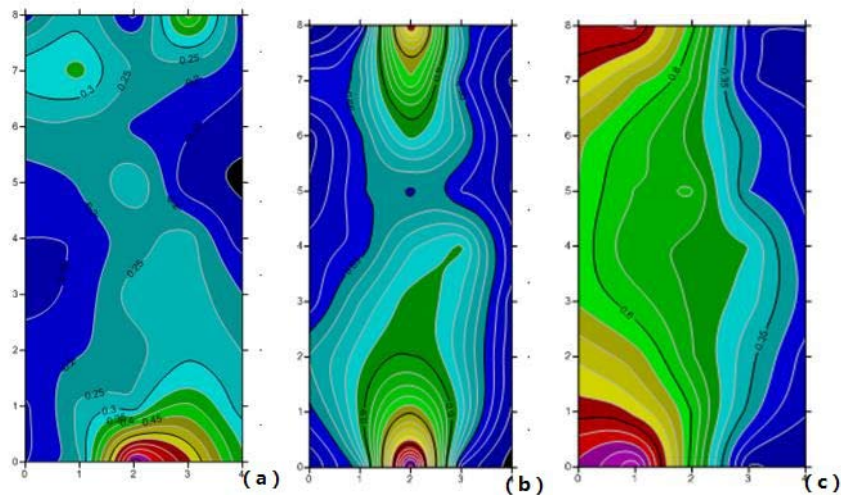

Figure 8 : The contour map of the x (a) , y (b) and z (c) component of the magnetic field.

It can be seen that, the x component along the leakage passage is relatively large, while the x component of the magnetic field strength on both sides is relatively small. The y component of magnetic field intensity is symmetrically distributed, and the Y component is the largest directly above the leakage channel, while the y component on both sides is relatively small. The z component of the magnetic field strength increases gradually from right to left, but the contour distribution on the left and right sides is basically symmetrical, and the center line of the contour distribution corresponds to the location of the leakage passage. From the model test, we proved that MMR is effective in detecting leakage passage.

4. CONCLUSIONS

This paper proposes a high precision detection technology for leakage passage in dam based on magnetoelectric resistivity method. Firstly we prove that the water content of the dam has a great influence on the electrical conductivity of the dam by soil test. This is the physical foundation of the MMR method. Then we describe the basic principle and feasibility of dam leakage detection by MMR method. We also propose the combination of rough and careful detection method for dam leakage passage and scupper. We suggest applying N current electrodes to dynamic track and accurate position the evolution process of the leakage passage. Numerical simulation and model test the technology proposed in this paper can detect the leakage passage quickly and accurately. The horizontal position of the leakage path will be reflected by the line segment connecting the contour “V” tip to the long elliptical axis. The magnetic field component which is close to the direction of the leakage path can more accurately represent the direction of the leakage passage. MMR method provides a new idea and guidance for the treatment and repair of the leakage in dam.

REFERENCES

- Asten M,W. 1991, Field examples of the downhole MMR method and comparison with the TEM method [C]. Nabighian,M,N,Electromagnetic methods in applied geophysics.Houston:SEG,1991:99-104
- Cho, L,K. 2007, Crossline resistivity tomography for the delineation of anomalous seepage pathways in an embankment dam[J]. Geophysics, 72(2):31-38
- Edwards, R.N. 1978a. On the theory of magnetometric resistivity (MMR) method [J], Geophysics, 43:1176-1203
- Goldman M,Neubauer F M. 1994, Groundwater exploration using integrated geophysical techniques[J].Surveys in Geophysics, 15(3):331-361.
- Matsuno T,Kimura M,Seama N. 2015. Electrical Resistivity Structure of the Snail Site at the Southern Mariana Trough Spreading Center[C]//Ishibashi J,Okino K,Sunamura M.Subseafloor Biosphere Linked to Hydrothermal Systems. Tokyo:Springer Japan, 241-251.
- Newman GA. 2014, A review of high-performance computational strategies for modeling and imaging of electromagnetic induction data[J].Surveys in Geophysics, 35:85- 100.
- Kim J,Supper R,Ottowitz D et al. 2016, A new measurement protocol of direct current resistivity data[J].Geophysics, 82(2):A7-A11.
- Kulesa B,Jaekel U,Kemna A,et al. 2002, Magnetometric resistivity (MMR) imaging of subsurface solute flow: inversion framework and laboratory tests[J].Journal of Environmental & Engineering Geophysics, 7(3):111-118.
- Kofoed, V O, Jessop M L, et al. 2011, Unique applications of MMR to track preferential groundwater flow paths in dams, mines, environmental sites, and leach fields[J]. Leading Edge, 30(2):192-204.
- Kofoed V O. 2013, Making accurate groundwater flow models[J].PollutionEngineering. 22:22-26.

- Li Y, Olednburg D W. 2003, Fast inversion of large-scale magnetic data using wavelet transforms and a logarithmic barrier method[J]. *Geophys. J. Int.*, 152:251-265.
- Ogilvy, A, A. 1969, Geophysical studies of water leakages from reservoirs[J]. *Geophysical Prospecting*, 27(1):36-72
- Pai, D, M. 1983, A programme for magnetometric resistivity 2D modeling by the finite difference method [R]. University of Toronto.
- Rozycki, A, 2006. Detection and evaluation of horizontal fractures in earth dams using the self-potential method.[J]. *Engineering Geology*, 82:145-153.
- Seama N, Tada N, Goto T N, et al. 2013, A continuously towed vertical bipole source for marine magnetometric resistivity surveying[J]. *Earth Planets & Space*, 65(8): 883-891.
- Wang T, Hohmann G W. 1993, A finite-difference time-domain solution for three-dimensional electromagnetic modeling[J]. *Geophysics*, 58(6):797-809.
- Yang, J. 2005. Geo-electrical responses associated with hydrothermal fluid circulation in oceanic crust: Feasibility of magnetometric and electrical resistivity methods in mapping off-axis convection cells [J]. *Exp. Geophys.*, 36:272-277.
- Zhu P, Y. 2007, Design of simulator for seepage detection in an embankment based on distributed optic fibre sensing technology[J]. *Chinese Journal of Science and Instruments*. 28(3):431-436.